



MIAMI-DADE COUNTY
 PRODUCT CONTROL SECTION
 11805 SW 26 Street, Room 208
 Miami, Florida 33175-2474
 T (786) 315-2590 F (786) 315-2599
www.miamidade.gov/economy

DEPARTMENT OF REGULATORY AND ECONOMIC RESOURCES (RER)
 BOARD AND CODE ADMINISTRATION DIVISION
NOTICE OF ACCEPTANCE (NOA)

Janus International Corporation
 134 Janus International Blvd.
 Temple, GA 30179

SCOPE: This NOA is being issued under the applicable rules and regulations governing the use of construction materials. The documentation submitted has been reviewed and accepted by Miami-Dade County RER-Product Control Section to be used in Miami Dade County and other areas where allowed by the Authority Having Jurisdiction (AHJ). This NOA shall not be valid after the expiration date stated below. The Miami-Dade County Product Control Section (In Miami Dade County) and/or the AHJ (in areas other than Miami Dade County) reserve the right to have this product or material tested for quality assurance purposes. If this product or material fails to perform in the accepted manner, the manufacturer will incur the expense of such testing and the AHJ may immediately revoke, modify, or suspend the use of such product or material within their jurisdiction. RER reserves the right to revoke this acceptance, if it is determined by Miami-Dade County Product Control Section that this product or material fails to meet the requirements of the applicable building code.

This product is approved as described herein, and has been designed to comply with the Florida Building Code, including the High Velocity Hurricane Zone.

DESCRIPTION: Series 3400 Steel Roll-Up Door up to 12'-0" Wide

APPROVAL DOCUMENT: Drawing No. T1011, titled "Dade County Commercial Door Series 3400, Max. Size 12'-0" x 20'-0", sheets 1 and 2 of 2, dated 03/16/2006, prepared by Janus International Corporation, signed and sealed by Joseph. H. Dixon Jr., P.E., bearing the Miami-Dade County Product Control revision stamp with the Notice of Acceptance number and expiration date by the Miami-Dade County Product Control Section.

MISSILE IMPACT RATING: Large and Small Missile Impact Resistant

LABELING: A permanent label with the manufacturer's name or logo, manufacturing address, model/series number, the positive and negative design pressure rating, indicate impact rated if applicable, installation instruction drawing reference number, approval number (NOA), the applicable test standards, and the statement reading 'Miami-Dade County Product Control Approved' is to be located on the door's side track, bottom angle, or inner surface of a panel.

LIMITATION: Operating (Roll-up) mechanism is not part of this approval. It must be certified by an independent testing agency, if required.

RENEWAL of this NOA shall be considered after a renewal application has been filed and there has been no change in the applicable building code negatively affecting the performance of this product.

TERMINATION of this NOA will occur after the expiration date or if there has been a revision or change in the materials, use, and/or manufacture of the product or process. Misuse of this NOA as an endorsement of any product, for sales, advertising or any other purposes shall automatically terminate this NOA. Failure to comply with any section of this NOA shall be cause for termination and removal of NOA.

ADVERTISEMENT: The NOA number preceded by the words Miami-Dade County, Florida, and followed by the expiration date may be displayed in advertising literature. If any portion of the NOA is displayed, then it shall be done in its entirety.

INSPECTION: A copy of this entire NOA shall be provided to the user by the manufacturer or its distributors and shall be available for inspection at the job site at the request of the Building Official.

This NOA revises NOA # 13-0124.05 and consists of this page 1 and evidence page E-1, as well as approval document mentioned above.

The submitted documentation was reviewed by Carlos M. Utrera, P.E.



[Signature]
 05/22/2015

NOA No. 15-0520.05
 Expiration Date: April 19, 2017
 Approval Date: May 28, 2015
 Page 1

NOTICE OF ACCEPTANCE: EVIDENCE SUBMITTED

A. DRAWINGS “Submitted under NOA # 06-0809.09”

1. Drawing No. **T1011**, titled “Dade County Commercial Door Series 3400, Max. Size 12’-0” x 20’-0””, sheets 1 and 2 of 2, dated 03/16/2006, prepared by Janus International Corporation, signed and sealed by Joseph. H. Dixon, Jr., P.E.

B. TESTS “Submitted under NOA # 13-0124.05”

1. Test report on Forced Entry Resistance Test per FBC, TAS 202-94 of a Series 3400, 24 Gauge Commercial Roll-up Door, prepared by Element Materials Technology, Test Report No. **ESP012111P-1**, dated 01/14/2013, signed and sealed by Thomas A. Kolden, P.E.

“Submitted under NOA # 06-0809.09”

2. Certified Testing Laboratories Report No. **CTLA-1493W**, pages 1 thru 5 of 5, dated 03/16/2006, signed and sealed on 03/17/2006 by Ramesh Patel, P.E. for Testing Standards TAS 201, TAS 202 and TAS 203.
3. Certified Testing Laboratories Report No. **1493W** for Galvanized Steel, dated 02/14/2006, signed and sealed on 03/17/2006 for Tensile Test per ASTM E8 by Ramesh Patel, P.E.

C. CALCULATIONS “Submitted under NOA # 06-0809.09”

1. Calculations for attachment of guide angles to steel or concrete jamb prepared by Joseph H. Dixon, Jr. PE, dated 02/03/2006, 18 pages, signed and sealed on 07/29/2006 by Joseph H. Dixon, Jr., PE.

D. QUALITY ASSURANCE

1. Miami-Dade Department of Regulatory and Economic Resources (RER)

E. MATERIAL CERTIFICATIONS

1. None.

F. STATEMENTS

1. Statement letter of code conformance to the 5th edition (2014) FBC, dated 03/04/2015, issued, signed and sealed by Joseph H. Dixon, Jr., P.E.

“Submitted under NOA # 12-0322.06”

2. Statement letter of code conformance to 2010 FBC, dated 03/14/2012, issued, signed and sealed by Joseph H. Dixon, Jr., P.E.

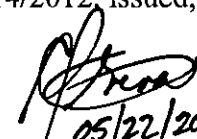

05/22/2015

Carlos M. Utrera, P.E.
Product Control Examiner
NOA No. 15-0520.05
Expiration Date: April 19, 2017
Approval Date: May 28, 2015

BRACKET ATTACHMENT
 CONCRETE/FILLED BLOCK: POWERS WEDGE-BOLT, 3/8 X 1-3/4" LONG
 STEEL: HEX BOLT, GR.5, 3/8-16 X 1-1/4" LONG

(*) FOR PUSH-UP OPERATION: 5-7/8" (*) (*)
 FOR HAND CHAIN OPERATION: 6-5/8" (*) (*) (*)
 FOR ELECTRIC OPERATION: 7-3/8" (*) (*) (*)
 FOR OUTSIDE OF CHAIN DRIVE: 8-1/8" (*) (*) (*)
 NOTE: RIGHT SIDE DRIVE SHOWN

(*) (*) DIMENSIONS SHOWN ARE FOR MOUNTING TO STEEL JAMBS. ADD 1-1/16" WHEN ATTACHING TO CONCRETE OR FILLED BLOCK JAMBS.

HEADROOM REQUIRED

OPENING HEIGHT	VERTICAL HEADROOM	HORIZONTAL HEADROOM
THRU 8'-0"	17'	19'
OVER 8'-0" THRU 10'-0"	19'	21'
OVER 10'-0" THRU 14'-0"	20'	22'
OVER 14'-0" THRU 16'-0"	21'	23'
OVER 16'-0" THRU 18'-0"	22'	24'
OVER 18'-0" THRU 20'-0"	23'	25'

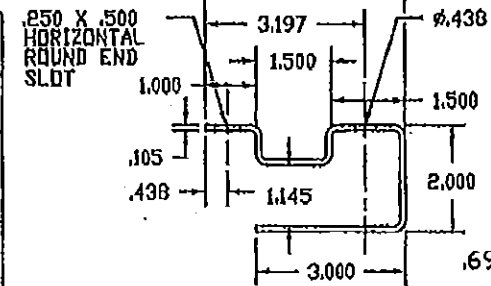

GUIDE
 G90 GALV STEEL
 ASTM A653 W/MIN
 FY=33 KSI
 CONTINUOUS
 FULL JAMB LENGTH

Florida Building Code
 Date: 04/19/2007
 NOAH 26-2809-09
 Miami Dade Product Control
 By: *[Signature]*

REVISIONS			
REV	DESCRIPTION	DATE	APPROVAL
---	DRAWING RELEASE	3-16-06	DM

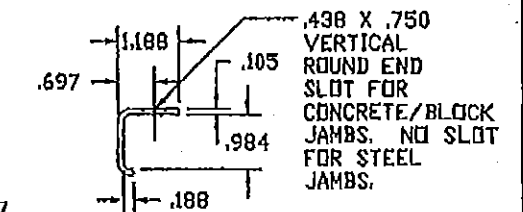

WIND BAR
 WIND BAR G90 GALV STEEL
 ASTM A653 W/MIN
 FY=33 KSI
 CONTINUOUS
 FULL GUIDE LENGTH

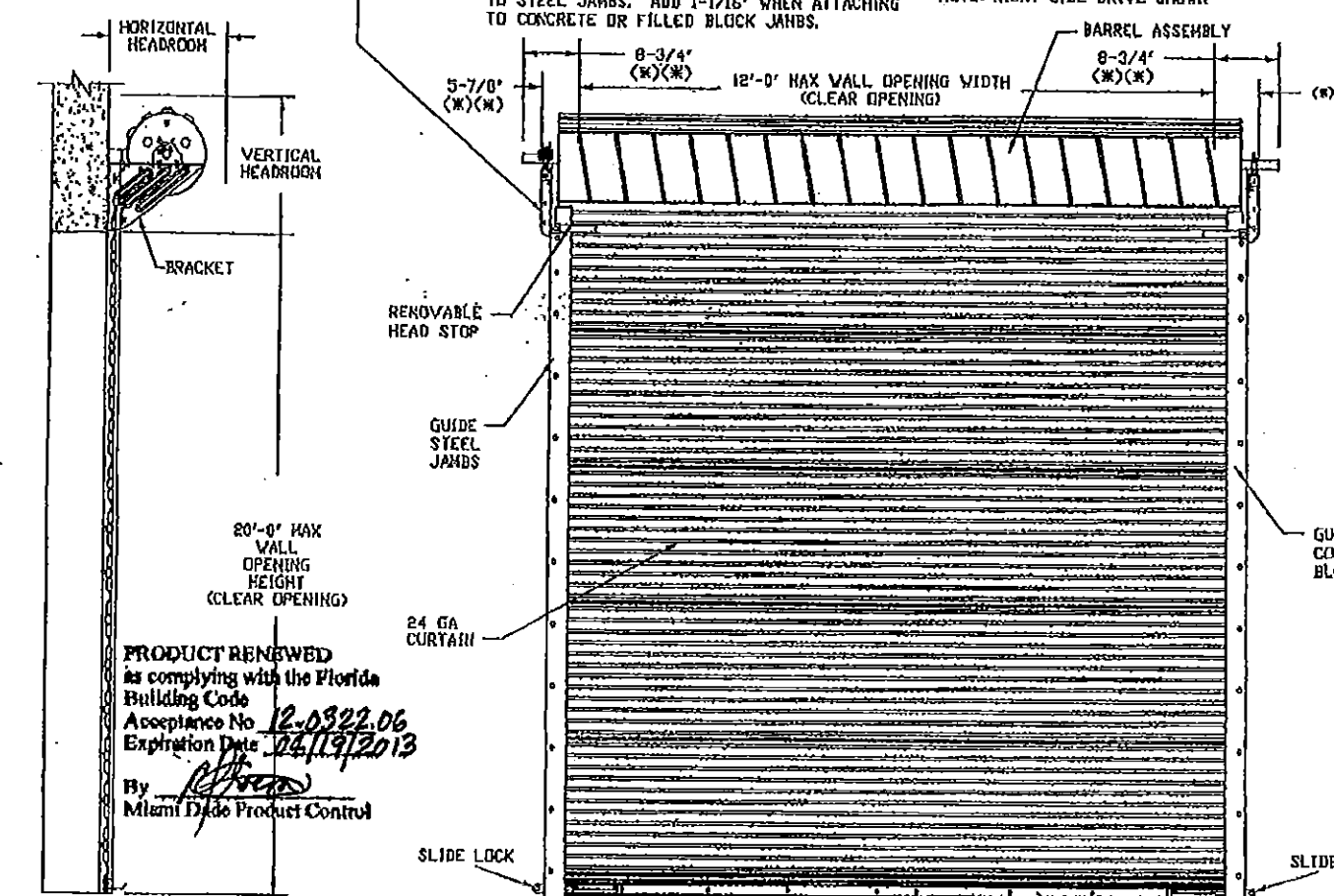
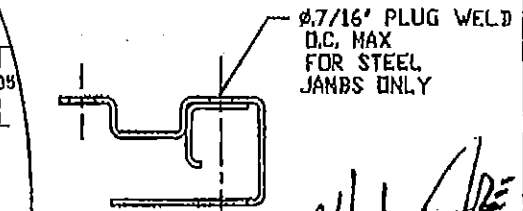

PRODUCT RENEWED
 as complying with the Florida Building Code
 Acceptance No 12-0322.06
 Expiration Date 04/19/2013
 By: *[Signature]*
 Miami Dade Product Control

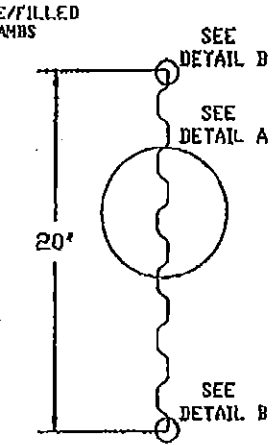

CURTAIN PANEL

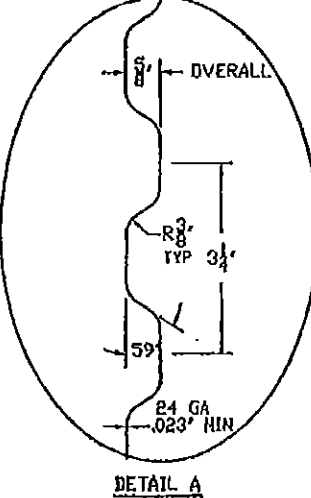

DETAIL A

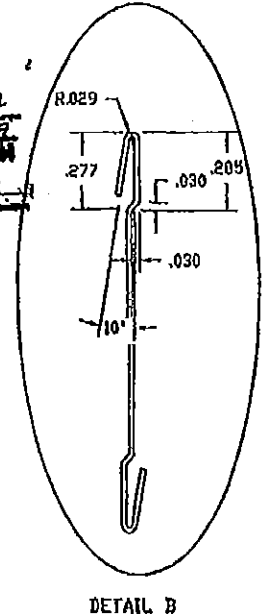

DETAIL B

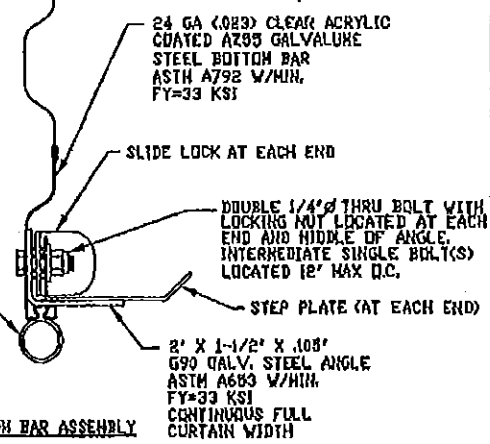

BOTTOM BAR ASSEMBLY

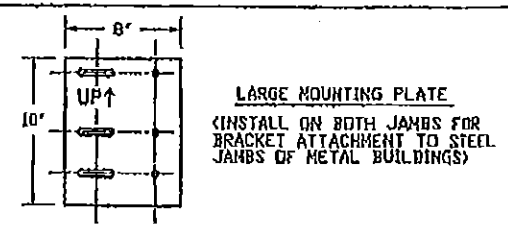

LARGE MOUNTING PLATE
 (INSTALL ON BOTH JAMBS FOR BRACKET ATTACHMENT TO STEEL JAMBS OF METAL BUILDINGS)

ASTH A653 GR 80 MIN FY=80 KSI.
 G90 GALVANIZED STEEL.
 CURTAIN PANELS LOCK SEAMED TOGETHER.
 PRE-PAINTED WITH A FULL COAT OF PRIMER
 AND BAKED SILICONIZED POLYESTER FINISH COAT.
CURTAIN DETAIL

PRODUCT REVISED
 as complying with the Florida Building Code
 Acceptance No 15-0520.05
 Expiration Date 04/19/2017
 By: *[Signature]*
 Miami Dade Product Control

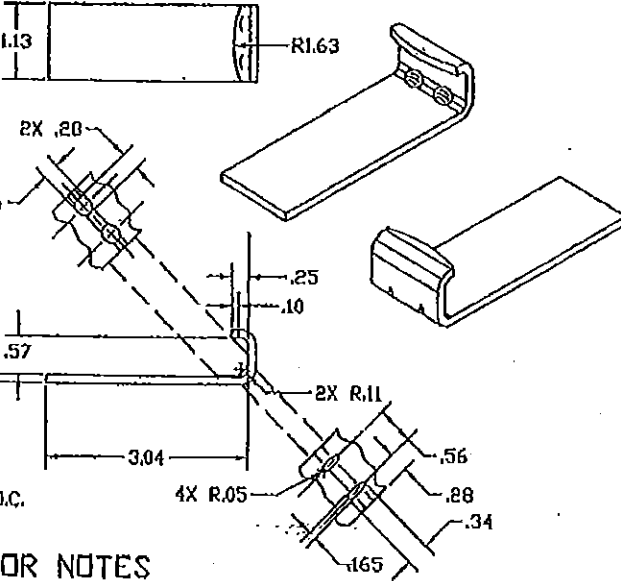

WINDLOCK
 MATERIAL:
 G90 GALV
 ASTM A653
 STRUCTURAL
 STEEL, GRADE 50,
 CLASS I
 MIN FY=50 KSI

WINDLOCK AT 3-1/4" O.C.

SEE SHEET 2 FOR NOTES

STRUCTURAL ENGINEER: JOSEPH H. DIXON, JR. P.E. FL #7768

UNLESS OTHERWISE SPECIFIED DIMENSIONS ARE IN INCHES AND TOLERANCES ARE:

DECIMAL	FRACTIONS	ANGLES	HOLE DIAMETERS
.XX ±.03	± 1/16	± 0° 30'	UNDER .251 +.004
.XXX ±.005			-.003
			.251 to .500 +.006
			-.003
			OVER .500 +.008
			-.003

PRODUCT RENEWED
 as complying with the Florida Building Code
 Acceptance No 13-0124.05
 Expiration Date 04/19/2017
 By: *[Signature]*
 Miami Dade Product Control

PART NUMBER: NA	
MATERIAL: NA	
APPLIED FINISH: NA	
UNIT OF MEASURE: NA	
APPROVALS	DATE
BECKY NELSON	1-20-06
DON MILLS	3-16-06
DON MILLS	3-16-06

JANUS INTERNATIONAL CORPORATION
 134 EAST LUKE ROAD TEMPLE, GA 30179-4435
 770-562-2850/Fax 770-562-2284
 © 2006 Janus International Corporation All Rights Reserved

DADE COUNTY COMMERCIAL DOOR SERIES 3400
 MAX. SIZE 12'-0" X 20'-0"

SIZE: B	DRAWING NUMBER: T1011	REVISIONS: ---
SCALE: NONE	SHEET: 1 OF 2	

GENERAL NOTES

- THIS ROLL-UP DOOR SYSTEM HAS BEEN SUCCESSFULLY TESTED ACCORDING TO THE UNIFORM STATIC AIR PRESSURE TEST PER TAS 202-94, THE LARGE MISSILE IMPACT TEST PER TAS 201-94 AND THE CYCLIC WIND PRESSURE LOADING TEST PER TAS 203-94, IN AN INDEPENDENT TESTING LAB CONFORMING TO TAS 301-94.
- THE DOOR IS DESIGNED TO COMPLY WITH THE MIAMI-DADE COUNTY PRODUCT CONTROL DIVISION FOR THE HIGH VELOCITY HURRICANE ZONE (HVHZ) OF THE FLORIDA BUILDING CODE.
- DESIGN LOAD RATING = +43.0 PSF POSITIVE WIND LOAD
-49.0 PSF NEGATIVE WIND LOAD
- WIND LOADS FOR BUILDING OPENINGS SHALL BE DETERMINED BY A PROFESSIONAL ENGINEER USING APPROPRIATE WIND SPEED AND DESIGN CRITERIA. THIS DOOR MAY BE USED WHERE ITS DESIGN LOAD MEETS OR EXCEEDS THE DESIGN LOAD REQUIRED FOR THE BUILDING OPENING.
- THE BUILDING ENGINEER SHALL VERIFY THE ADEQUACY OF THE BUILDING STRUCTURE TO WITHSTAND SUPERIMPOSED LOADS P_{wpf}, P_{ypf} + R_{ypf}, P_{xnf} AND P_{ynf} + R_{ynf}.
- EACH MIAMI-DADE COUNTY DOOR ASSEMBLY SHALL BE LABELED AS FOLLOWS:

JANUS INTERNATIONAL CORPORATION
TEMPLE, GA
MIAMI-DADE COUNTY PRODUCT CONTROL APPROVED
- ALL WELDING SHALL BE PERFORMED BY QUALIFIED WELDERS IN ACCORDANCE WITH THE LATEST EDITION OF AWS SPECIFICATIONS. ALL WELDING ELECTRODES SHALL CONFORM TO AWS A5.1, GRADE E-70.
- ALL BOLTS AND WASHERS SHALL BE GALVANIZED STEEL OR STAINLESS STEEL WITH A MINIMUM TENSILE STRENGTH OF 60 KSI.
- DOORS SHALL BE PROVIDED WITH DOUBLE BOTTOM BAR MOUNTED SLIDE LOCK LATCHES THAT ENGAGE THE DOOR GUIDES WHEN DOOR IS FULLY CLOSED.
- DOOR ASSEMBLY DESIGN BASED ON CERTIFIED TESTING LABORATORIES, INC., TEST REPORT NO. CTA-1493W.
- ANCHOR NOTES:
A. EMBEDMENT LENGTH DOES NOT INCLUDE STUCCO FINISH.
B. FOR HOLLOW MASONRY BLOCK, FILL ALL CELLS AT ANCHOR LOCATIONS WITH MINIMUM 2000 PSI GROUT.
C. CONCRETE JAMBS TO BE MINIMUM 2000 PSI.
D. ANCHORS SHALL BE INSTALLED IN ACCORDANCE WITH MANUFACTURER'S SPECIFICATIONS.
- GUIDE TO JAMB ATTACHMENT FASTENERS BEGIN 4" FROM FLOOR AND END 2" BELOW TOP OF WALL OPENING.
- TEST DOOR WALL OPENING SIZE 12'-0" X 8'-0".

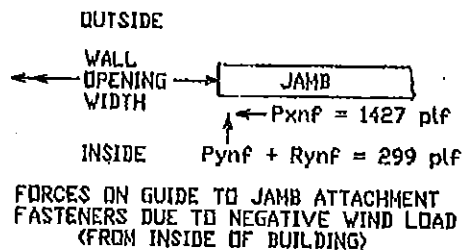
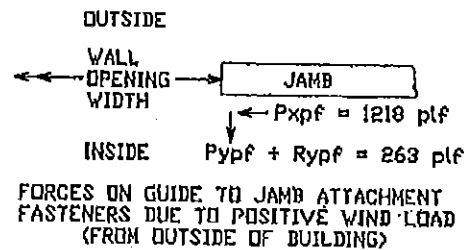

STEEL JAMBS

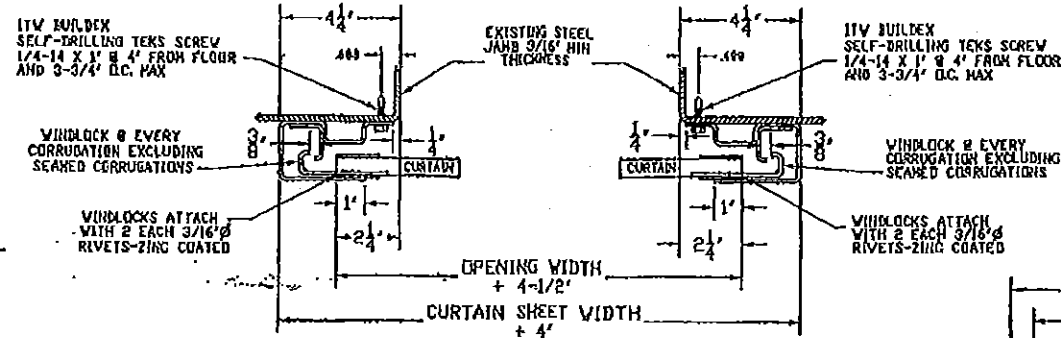

PRODUCT REVISED
as complying with the Florida Building Code
Acceptance No 15-0520.05
Expiration Date 04/19/2017
By *[Signature]*
Miami Dade Product Control

FILLED BLOCK JAMBS

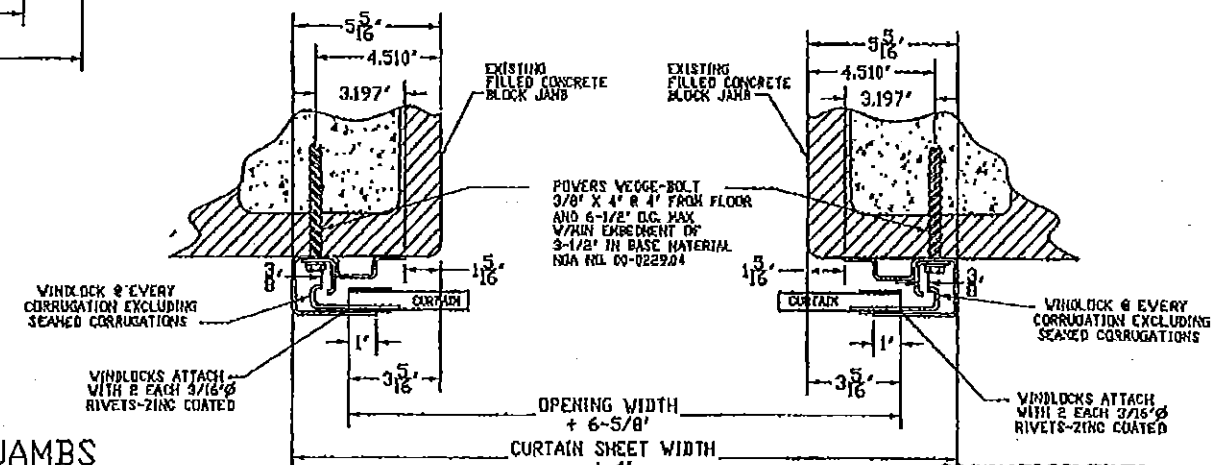

PRODUCT RENEWED
as complying with the Florida Building Code
Acceptance No 12-0322.06
Expiration Date 04/19/2013
By *[Signature]*
Miami Dade Product Control

CONCRETE JAMBS

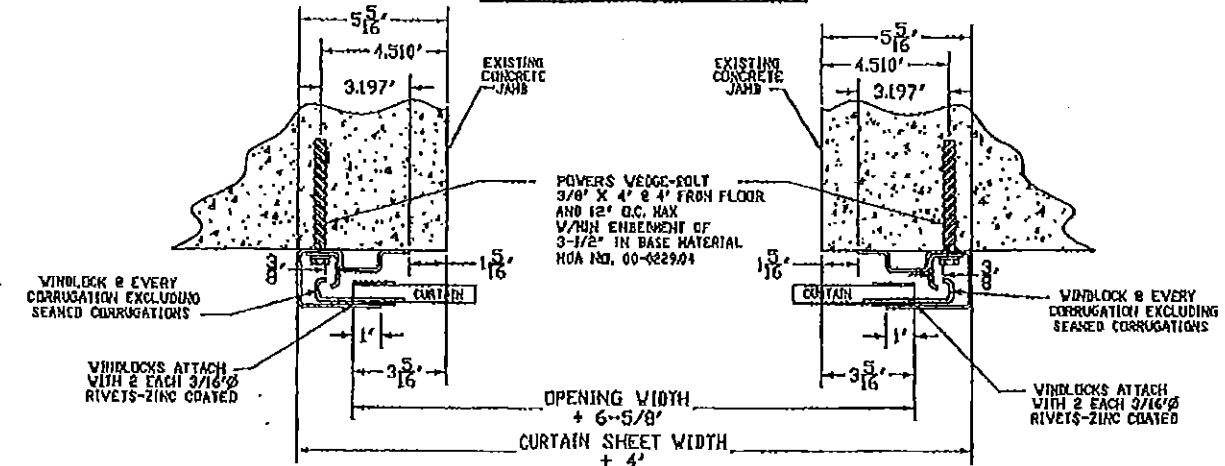

Approved as complying with the Florida Building Code
Date 02/19/2007
By *[Signature]*
Miami Dade Product Control

[Handwritten Signature]
7/29/06

STRUCTURAL ENGINEER: JOSEPH H. DIXON, JR. P.E. FL #7768

UNLESS OTHERWISE SPECIFIED DIMENSIONS ARE IN INCHES AND TOLERANCES ARE:

DECIMAL	FRACTIONS	ANGLES	HOLE DIAMETERS
.XX ±.03	± 1/16	± 0° 30'	UNDER .251 +.004 -.003
.XXX ±.005			.251 to .500 +.006 -.003
			OVER .500 +.008 -.003

PART NUMBER: NA		JANUS INTERNATIONAL CORPORATION	
MATERIAL: NA		134 EAST LUKE ROAD TEMPLE, GA 30179-4435	
APPLIED FINISH: NA		770-562-2850/Fax 770-562-2264	
UNIT OF MEASURE: NA		© 2008 Janus International Corporation All Rights Reserved	
APPROVALS: DATE		DADE COUNTY COMMERCIAL DOOR SERIES 3400	
DRAWN: BECKY NELSON	1-20-06	MAX. SIZE 12'-0" X 20'-0"	
CHECKED: DON MILLS	3-16-06	SIZE: B	DRAWING NUMBER: T1011
APPROVED: DON MILLS	3-16-06	SCALE: NONE	SHEET: 2 OF 2